

# STRIKER

## DETECTORS

Model# Z60

User's Manual

# Table of Contents



Terms .....	3-4
Contents .....	5-6
Assembly .....	7-9
LCD Display .....	10
Category Value .....	11
How it Works .....	12-14
Detector Modes .....	15-16
How to Detect .....	17-18
Courtesy .....	19
Warning .....	20
Tone Recognition .....	21
Trouble Shooting .....	22
Warranty/Services .....	23-24
FCC Statement .....	25

# TERMS TO KNOW



The terms below are standard words found within this manual and the detector.

## **DISCRIMINATION**

Discriminating allows you to choose the metals you want to detect and the ones you want to “eliminate” or not look for. Discrimination makes it easier to avoid trash or other undesirable objects. Once it detects a metal it will categorize it to one of the metals you chose to detect for.

## **IRON**

Iron is the most common metals. It has been used since ancient times because of its abundance. Ferrous metals are made up of iron. Objects that are ferrous metals are; nails, bolts, stainless steel, and cast iron.

## **PINPOINT**

A narrow zone of detection that tells you the exact location of the object by increasing sensitivity and reducing the detection cone.

## **PULL-TABS**

Also known as “pop tops.” Discarded pull-tabs come from beverage cans. They can be all different shapes and sizes. They are primarily made of aluminum; they can be bothersome to many treasure hunters

.

## **GROUND GRAB\***

All soils contain minerals. Signals from ground minerals interfere with the signals from metal objects. If metal is detected in this mode it will make a sound. It doesn't detect any of earth's natural minerals so you can get a more accurate reading on what you find. Put simply, Ground Grab analyzes the signature of the natural minerals and local conditions and compensates for their frequencies so that only actual targets register a hit.

*\*our clever name for ground balancing*

# CONTENTS

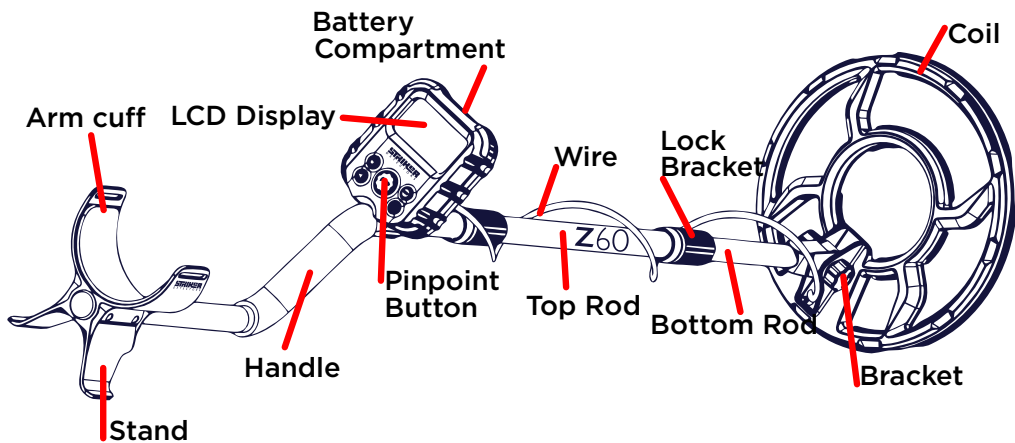

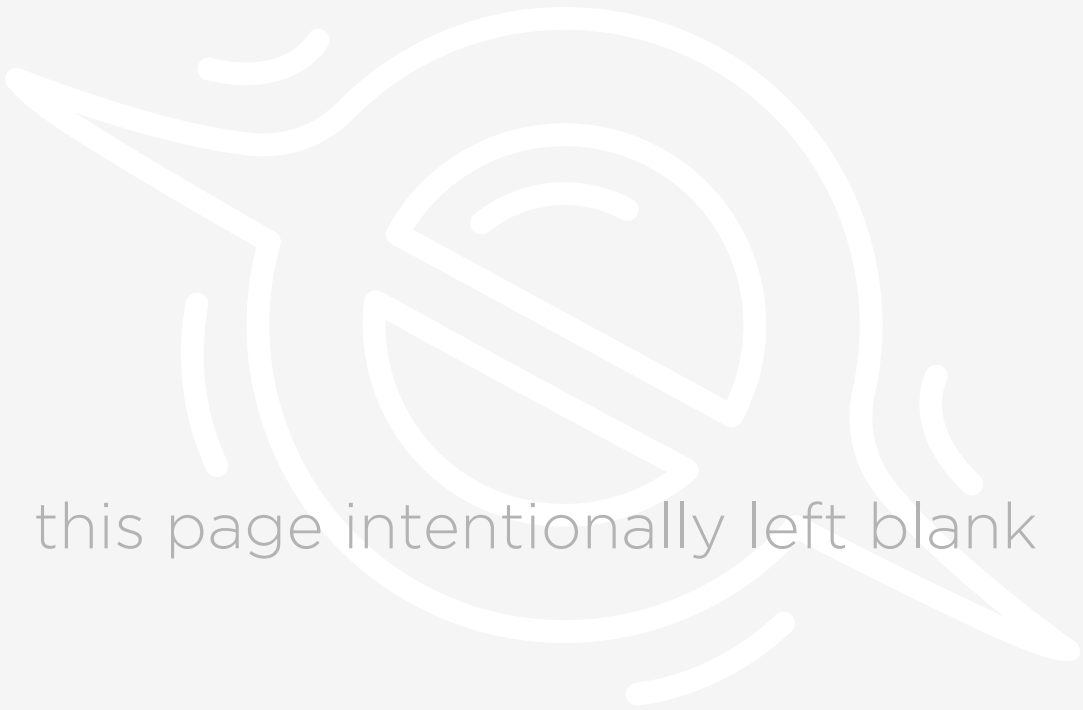

this page intentionally left blank

# ASSEMBLY



## 1 Assembling the coil unit

Unscrew the bracket from the bottom rod. Fit the bottom rod inside the coil and replace the bracket. Then tighten. Please be careful not to overtighten. **NOTE: The large hole faces down.**

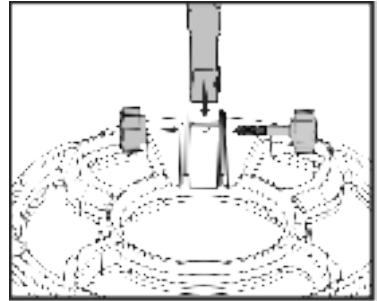

## 2 Connect The Rods

Connect the Top Rod to the Bottom Rod by sliding the Top Rod with the Locking Bracket end down. Note: The groove on the Top Rod needs to face away from you. Align grooves to one another to ensure rods stay in place. Slide the Top Rod to the desired length and tighten the Locking Bracket by turning it to the left.

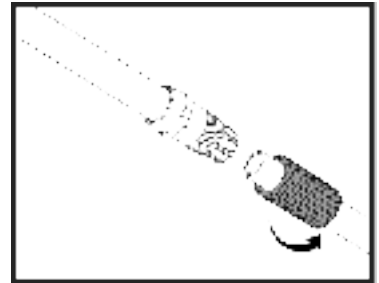

3

## Connecting the Handle Unit

Unscrew the bracket from the bottom rod. Fit the bottom rod inside the coil and replace the bracket. Then tighten. Please be careful not to overtighten. **NOTE: The large hole faces down.**

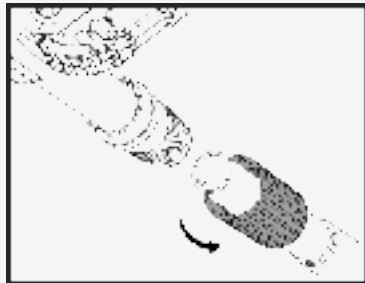

4

## Connecting the Wiring

Take the cord that is connected to the coil and wrap it around the rods. Continue wrapping up around the rods and then plug it into the back of the LCD display.

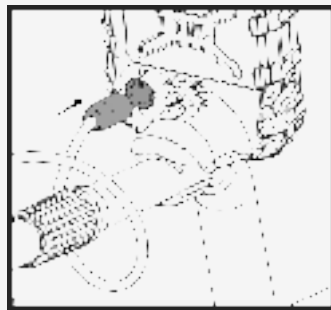



# Batteries



1

Take the cord that is connected to the coil and wrap it around the rods. Continue wrapping up around the rods and then plug it into the back of the LCD display.

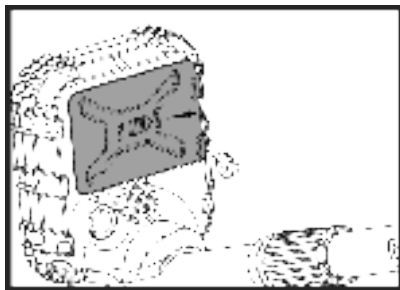

2

Insert 6 AAA batteries according to the markings within the compartment. Caution: Never mix old and new batteries. Never mix alkaline, carbon-zinc or rechargeable batteries.

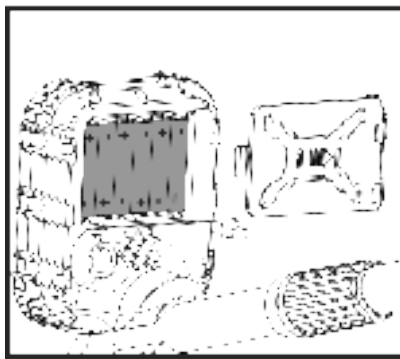

3

Replace the battery compartment back when finished.

# LCD NAVIGATION DISPLAY

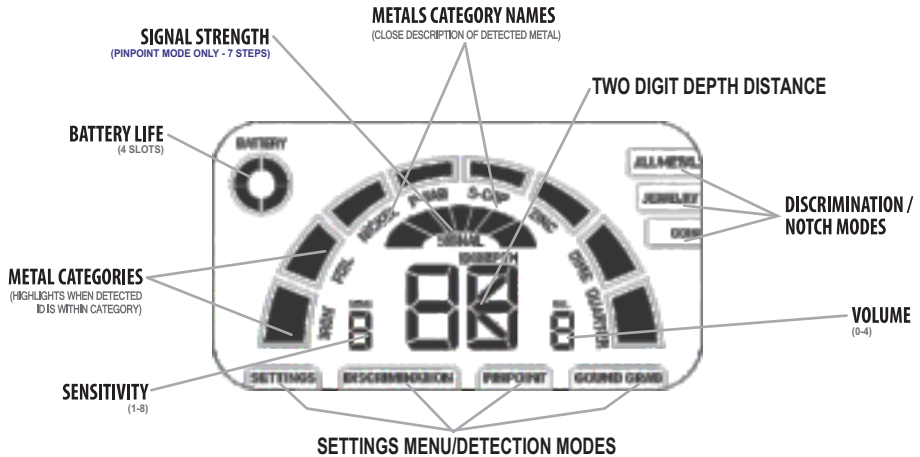

# CATEGORY VALUE

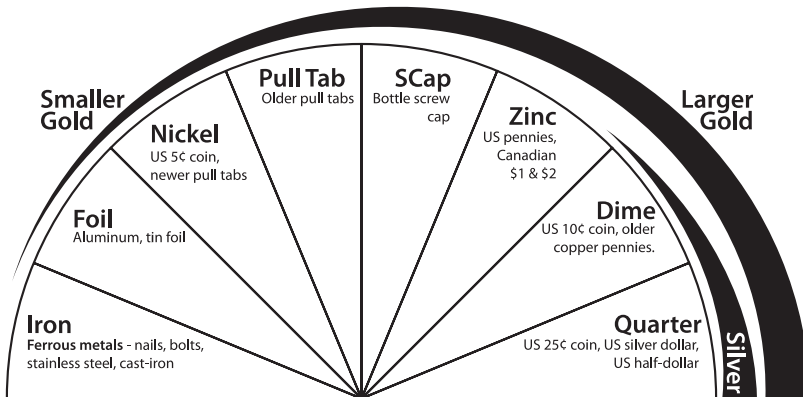

## METALS DIAGRAM

\* Silver and Gold can be in multiple spectrums











# HOW IT WORKS



# HOW IT WORKS









## Settings

- Press  to enter "Settings" Mode
- Press   to move between Volume, Sensitivity and Discrimination
- Press  while Volume is selected to enter Volume options
- Press   to change the Volume
- Press  while Sensitivity is selected to enter Sensitivity options
- Press   to change the Sensitivity
- Press  to detect in current settings

### Ground Grab

- Press  to Ground Grab (ground balance)

### Discrimination

- Press  and then  (This mode uses your last Settings to detect)
- Press  to enter “Discrimination” Mode
- Use   to move to desired setting
- Press  to begin detecting in the selected option

### Pin Point

- Press and hold  to enter “Pin Point” Mode



# DETECTOR MODES



## Ground Grab

All soils contain minerals. Signals from ground minerals interfere with the signals from metal objects. All soils differ, and can differ greatly in the type and amount of ground minerals present. This detector incorporates ground balancing algorithms which eliminate interference caused by the ground minerals found in most soils. We therefore recommend that you use GROUND GRAB to most accurately calibrate the detector to the specific ground conditions where you are hunting. This process will maximize the detector's target identification accuracy and depth detection capability. This step is critical.

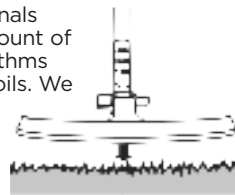

## Ground Grab steps are as follows: (ground balance)

1. Find a patch of ground which is free of metal. Use the DISCRIMINATION mode, with no targets discriminated out.
2. Hold the detector with the search coil about 6 inches above the ground, then press the GG button to activate the ground grab process, then lower the coil down to within 2 inches off the ground.
3. Repeat to lift up and lower down the search coil several times until the LCD shows "GRAB OK". If 'GRAB ER' appears, maybe the ground is too dirty with metal trash or just wet salt soil. Find another place and repeat the ground grab again until you see GRAB OK. Ground grab results are crucial to the performance and especially of PP mode.

## Discrimination

Pick the discrimination mode you want to detect in. Keep the coil parallel to the ground moving it from left to right with a stable speed. Out of the metals highlighted it will categorize the metal detected so you are aware of what metal is buried. It will inform you in two ways;

1. by highlighting the metal detected and
2. a tone response. Discrimination identification accuracy can be influenced by moisture and temperature. The coil sweeping speed can also affect discrimination, generally faster sweeping motion has a higher sensitivity.

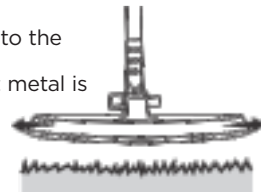

## Pinpointing

Pinpoint does a narrow search that will give you the exact location of a buried object. It will identify an object by a signal and tone response. Hold the PP button to activate the pinpoint function. Once activated, sweep the coil over the target area in an "X" pattern. Make a visual note of the place on the ground where the strongest signal is identified. Then dig in the center of the "X." When the button is released the metal detector will return back to the previous mode. NOTE: Normally, the detector takes about 5 minutes to stabilize after it powers on, it is not recommended to do pinpointing during this period of time. The sensitivity of the detector will drift over time. If sensitivity drifts upward, the detector will sound off spontaneously. If sensitivity drifts downward, the detector will become less sensitive. Drift is exacerbated by the environment condition change especially the temperature change. In case the sensitivity drifts simply perform a Ground Grab again.

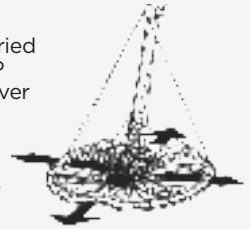

## Notch Modes

When in Notch there are three options:

**All Metals:** Use this mode if you are looking for a wide range of objects. It is designed to find all metal objects

**Coin:** When using this mode it will show you the metals found in coins. It is designed to find all types of coins and eliminate trash objects such as iron and foil.

**Jewelry:** When in this mode it will show you the metals common in jewelry. It is designed to find jewelry such as rings, bracelets, watches and necklaces. When an object is detected it will highlight the name of the metal found as well as use a tone that identifies the metal.





# HOW TO DETECT



## STEP

1

Power ON by pushing the “POWER” button.

## STEP

2

Press the “SETTINGS” button. There will be three options to choose from:

OPTION 1: Use the “<” and “>” arrow keys to the Sensitivity option and press the “PP” button to select. While in Sensitivity you can change the sensitivity by using the “<” and “>” arrow keys. Press “PP” to save.

OPTION 2: Use the “<” and “>” arrow keys to the Volume option and press the “PP” button to select. While in Volume you can change the volume by using the “<” and “>” arrow keys. Press “PP” to save.

OPTION 3: Use the “<” and “>” arrow keys to the Discrimination option and press the “PP” button to select. While in Discrimination you can eliminate certain metals by selecting either All Metal, Jewelry or Coin. Use the “<” and “>” arrow keys to scroll to the option you want. Press “PP” to save.

POWER



SET

SETTINGS

“<”



“PP”



“>” & “GG”



**STEP  
3**

Press the “GG” button to perform a Ground Grab see p15. Display will show “OK” when ground grab is completed. If “ERROR” shows, there may be a metal object underground, find another clean area nearby to retry ground grab.

**STEP  
4**

While in Discrimination Mode keep the coil parallel to the ground moving it from left to right with a stable speed. If it finds something it will highlight the metal found and give off a certain tone (refer to page 11).

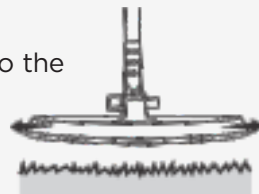

**STEP  
5**

When a metal is detected, hold the “PP” button to activate Pinpoint function. Sweep the coil over the target in an “X” pattern. While in PinPoint it will show you the depth of the metal found. So you can accurately know how far down to dig.



**STEP  
6**

Dig objects out.

**STEP  
7**

Once the object is found, fill the hole back up to the way you found it.

# COURTESY



## PLEASE

- Fill holes
- Obey NO TRESPASSING signs
- Respect private and public property
- Obey all laws
- Do not cause any willful damage to property
- Do not destroy property
- Pick up after yourself, do not leave trash



# WARNING



**All metal detector's may discover objects that can cause personal injury if struck.** For example; power lines, explosives, gas lines, etc.

When searching for treasure, first observe these precautions:

- Do not use a detector where you think there might be electrical lines or pipes buried below the surface.
- Do not use a detector in a military area where bombs or other explosives were once buried.
- Avoid striking any lines that are or could be electrically powered. Keep away from pipelines they could be carrying flammable gas or liquid.



# tone RECOGNITION



There are eight tones indicating 8 different metals (iron, foil, nickel, P-Tab, S-Cap, Zinc, Dime and Quarter) that will help you to identify the material the detector has found.

# TROUBLESHOOTING

## PROBLEM

## SOLUTION

**Won't turn ON,  
there is no sound**

- ✦ Check to ensure that you are using new batteries.
- ✦ Check to see if the batteries were placed in the correct positions.
- ✦ Check the connection of the wire from the coil to control box

**Abnormal/erratic  
Sounds**

- ✦ Outdoor use only.
- ✦ Stay away from power lines, benches wire fences and other metal detectors that can cause false readings.
- ✦ Reduce the sensitivity level.

**Abnormal/erratic  
Sounds**

- ✦ Check that the Mode you wanted is selected.
- ✦ The All-metals mode allows you to search for all metals so you will not miss the one you are looking for.

## **DISCLAIMERS**

Striker Detector products are not designed or intended for medical or security uses or for detection on the human body. Know and understand the applicable laws for use of metal detection devices. Metal Detecting, LLC dba Kellyco Metal Detectors (“Kellyco” or “We”) is not responsible for damage, expense, or injury caused by improper, illegal, or unauthorized use of, alterations to, improper connection of, or abuse or neglect of the Striker Detector™ product. Kellyco reserves the right to make changes to product features, functionality and physical design at its sole discretion. As a result, such changes may not be reflected in this version of the manual.

## **KELLYCO 1-YEAR LIMITED WARRANTY**

### **IMPORTANT INFORMATION ABOUT YOUR RIGHTS AND OBLIGATIONS, AS WELL AS LIMITATIONS AND EXCLUSIONS THAT MAY APPLY TO YOU.**

#### **1. What This Limited Warranty Covers; Period of Coverage**

This Limited Warranty applies to the Striker Detector™ (the “Product”) distributed by Kellyco, LLC (“Kellyco”). Kellyco warrants to the owner of the Product that the Product will be free from defects in materials and workmanship for a period of one (1) year from the date of original purchase (the “Warranty Period”). If the Product fails to conform to the Limited Warranty during the Warranty Period, Kellyco will, at its sole discretion, either (a) repair or replace any defective Product; or (b) accept the return of the product and refund the money actually paid by purchaser for the product. If the Product is no longer available, replacement may be made with a similar product of equal or greater value, at Kellyco’s sole discretion. This is your sole and exclusive remedy for breach of this warranty. Any Product that has either been repaired or replaced under this Limited Warranty will have warranty coverage for the longer of ninety (90) days or the remaining Warranty Period. This Limited Warranty is transferable from the original purchaser to subsequent owners, but the Warranty Period will not be extended in duration or expanded in coverage for any such transfer.

#### **2. Total Satisfaction Return Policy**

If you are not satisfied with this product for any reason, you may return it within thirty (30) days of the original purchase and receive a full refund.

#### **3. Warranty Conditions; How to Get Service**

If you believe the Product may be defective, you may contact Kellyco at 347-508-9608. Kellyco’s warranty obligations are conditioned on the owner (a) notifying Kellyco by calling the number above during the Warranty Period and providing a description of the alleged failure, and (b) complying with Kellyco’s’ return shipping instructions, and (c) shipping the product, at owner’s cost, to Kellyco for repair or replacement. Unless otherwise specified herein, Kellyco will bear all costs of return shipping to owner.

HOWEVER, Kellyco will have no warranty obligations with respect to a returned Product, including but not limited to costs of return shipping to owner, if Kellyco determines, in its sole discretion after examination of the returned Product, that this Limited Warranty does not apply to the Product for any of the reasons set forth in Section 4 below.

When returning product(s) for service you MUST obtain a Return Merchandise Authorization (RMA) number from Kellyco, Please include name, UPS address (No P.O. Box), telephone number, RMA number and a complete description of the problem on all enclosed correspondence. When possible, pack product carefully in original carton. Kellyco is not responsible for damage incurred in returning items for repair.

**For product service, send to:**

Kellyco  
120 Market Place Boulevard, Suite H  
Knoxville, TN 37922

**4. What This Limited Warranty Does Not Cover**

This Limited Warranty does not cover any of the following:

- 1) Damage to any Product on which the serial number or other identifying markings have been removed or made illegible;
- 2) Damage caused by any modifications, alterations, tampering, or improper maintenance or repairs to the Product;
- 3) Damage resulting from handling, storage, installation, or use of the Product which is improper or not in accordance with Kellyco® instructions.
- 4) Damage resulting from the addition of accessories not approved by Kellyco;
- 5) Damage caused by abuse, theft, accident, misuse, neglect, poor maintenance, failure to maintain the Product, or animal damage, as determined by Kellyco in its discretion.
- 6) Freight damage; and
- 7) Shipping, taxes, customs fees, or other costs accrued in the process of returning an item to Kellyco, unless otherwise determined by Kellyco in its sole discretion;

**5. DISCLAIMER OF WARRANTIES**

EXCEPT AS STATED ABOVE IN THIS LIMITED WARRANTY, AND TO THE MAXIMUM EXTENT PERMITTED BY APPLICABLE LAW, KELLYCO DISCLAIMS ALL EXPRESS, IMPLIED, AND STATUTORY WARRANTIES WITH RESPECT TO THE PRODUCT, INCLUDING THE IMPLIED WARRANTIES OF MERCHANTABILITY AND FITNESS FOR A PARTICULAR PURPOSE. IF APPLICABLE LAW DOES NOT PERMIT DISCLAIMER OF IMPLIED WARRANTIES, KELLYCO ALSO LIMITS THE DURATION OF ANY IMPLIED WARRANTIES TO THE DURATION OF THIS LIMITED WARRANTY.

**6. LIMITATION OF DAMAGES**

IN ADDITION TO THE ABOVE WARRANTY DISCLAIMERS, IN NO EVENT WILL KELLYCO BE LIABLE FOR ANY CONSEQUENTIAL, INCIDENTAL, EXEMPLARY, OR SPECIAL DAMAGES, INCLUDING ANY DAMAGES FOR LOST PROFITS, ARISING FROM OR RELATING TO THIS LIMITED WARRANTY OR THE PRODUCT, AND KELLYCO'S TOTAL CUMULATIVE LIABILITY ARISING FROM OR RELATED TO THIS LIMITED WARRANTY OR THE PRODUCT WILL NOT EXCEED THE AMOUNT ACTUALLY PAID FOR THE PRODUCT BY THE ORIGINAL PURCHASER.

**7. State or Non-U.S. Law**

Some states and/or non-US jurisdictions do not allow limitations on how long an implied warranty lasts or exclusions/limitations on incidental or consequential damages, so the above limitations may not apply to you. This warranty gives you specific legal rights, and you may also have other rights which vary from state to state or from jurisdiction to jurisdiction. The disclaimers, exclusions, and limitations of liability under this limited warranty will not apply to the extent prohibited by applicable law.



## FCC STATEMENT

**Product Name: Metal Detector**  
**Trade Name: Striker Detectors**  
**Model# z60**

This device complies with Part 15 of the FCC Rules. Operation is subject to the following two criteria: (1) This device may not cause harmful interference, and (2) This device must accept any interference received, including interference that may cause undesired operation.

Warning: Changes or modifications to this unit not expressly approved by the party responsible for compliance could void the user's authority to operate the equipment.

NOTE: This equipment has been tested and found to comply with the limits for a Class B digital device, pursuant to Part 15 of the FCC Rules. These limits are designed to provide reasonable protection against harmful interference in a residential installation. This equipment generates, uses and can radiate radio frequency energy and, if not installed and used in accordance with the instructions, may cause harmful interference to radio communications.

However, there is no guarantee that interference will not occur in a particular installation. If this equipment does cause harmful interference to radio or television reception, which can be determined by turning the equipment off and on, the user is encouraged to try to correct the interference by one or more of the following measures:

- Reorient or relocate the receiving antenna.
- Increase the separation between the equipment and receiver.
- Connect the equipment into an outlet on a circuit different from that to which the receiver is connected.
- Consult the dealer or an experienced radio/TV technician for help.

# QUICK GUIDE



## SITUATION

## actions

### Lost Ring

- perform ground grab p15
- set mode to Jewelry
- set sensitivity to 6
- keep the coil perpendicular to the ground and about 2" off
- slowly scan the area using a grid pattern
- if unsuccessful try All Metal mode and repeat

### Property Marker

- perform ground grab p15
- set mode to All Metal
- set sensitivity to 4
- keep the coil perpendicular to the ground and about 2" off
- slowly scan the area using a grid pattern
- if unsuccessful increase sensitivity and repeat

### Buried Coins

- perform ground grab p15
- set mode to Coins
- set sensitivity to 8
- keep the coil perpendicular to the ground and about 2" off
- slowly scan the area using a grid pattern
- if unsuccessful try All Metal mode and repeat

**Model#** z60

**Power Source:** 6Pcs. of AAA-Cell Alkaline Batteries

This device complies with Part 15 of the FCC Rules. Operation is subject to the following two criteria: (1) This device may not cause harmful interference, and (2) This device must accept any interference received, including interference that may cause undesired operation.

**Warning:** Changes or modifications to this unit not expressly approved by the party responsible for compliance could void the user's authority to operate the equipment.

**Made in China**

**strikerdetector.com**

<sup>get</sup>**STRUCK**

**STRIKER DETECTORS**

120 Market Place Boulevard, Suite H  
Knoxville, TN 37922  
347-508-9608

